

# WHEN YOUR REPUTATION DEPENDS ON PRECISION

## COMPOUNDS

We utilize the following polymers to develop products that provide superior protection for your bearings, processes, and equipment. Note that these grades and types do not necessarily represent all possibilities for usage. Please contact us for more information.

ASTM	NAME
ACM	Polyacrylate (HyTemp®)
AEM	Ethylene Acrylic (Vamac®)
CR	Chloroprene (Neoprene)
CSM	Chlorosulfonated Polyethylene (Hypalon®)
ECO	Epichlorohydrin (Hydrin®)
EPDM	Ethylene Propylene Diene Rubber (Vistalon®)
EPM	Ethylene Propylene Rubber
EVM	Ethylene Vinyl Acetate (Levapren®)
FEPM	Polymethylene Type Fluoroelastomer (Aflas®, Technoflon®)
FFKM	Perfluorinated Elastomer (Kalrez®, Tecnoflon®)
FKM/FPM	Fluoroelastomer (Viton®, Fluorel®, Tecnoflon®)
FVMQ	Fluorosilicone
HSN/HNBR	Hydrogenated Nitrile Rubber (Therban®, Zetpol®)
IIR	Butyl Rubber
IR	Synthetic Isoprene (Natsyn®)
NBR	Nitrile Rubber
NR	Natural Rubber
SBR	Styrene Butadiene Rubber
VMQ	Silicone (Siliastic®)

## BONDED SUBSTRATES

- Aluminum
- Brass
- Low Carbon Steel
- PTFE (Teflon®)
- Reinforced PTFE (Teflon®)
- Stainless Steel
- Titanium

HyTemp® and Hydrin® are registered trademarks of Zeon Chemicals L.P. Vamac®, Hypalon®, Viton®, Kalrez®, and Teflon® are registered trademarks of E. I. du Pont de Nemours and Company or its affiliates. Levapren® and Therban® are registered trademarks of Lanxess Deutschland GmbH. Vistalon® is a registered trademark of Exxon Mobil Corporation. Aflas® is a registered trademark of Asahi Glass Co., Ltd. Fluorel® is a registered trademark of 3M Company. Zetpol® is a registered trademark of Zeon Corporation. Tecnoflon® is a registered trademark of Solvay Specialty Polymers Italy, SpA. Natsyn® is a registered trademark of The Goodyear Tire & Rubber Company. Siliastic® is registered trademark of Dow Corning Corporation.



### Cooper Products Worldwide Headquarters

210 Fair Street, Laconia, NH 03246 USA  
Phone: 603.524.3367  
Fax: 603.524.4620  
seals@cooperproducts.com

### Cooper Europe

BWD Automotive GmbH  
Schnackenburgallee 47-51  
22525 Hamburg, Germany  
+49 (0) 40 89 05 92 0  
+49 (0) 40 89 05 92 33 (fax)  
seals-eu@cooperproducts.com

**For more information or to submit your specifications, please visit us at [www.cooperproducts.com](http://www.cooperproducts.com).**

ISO/TS 16949:2009 certified



## COOPER PRODUCTS

OUR SEALING SOLUTIONS PROTECT MORE THAN BEARINGS, EQUIPMENT, AND PROCESSES. THEY PROTECT YOUR REPUTATION.

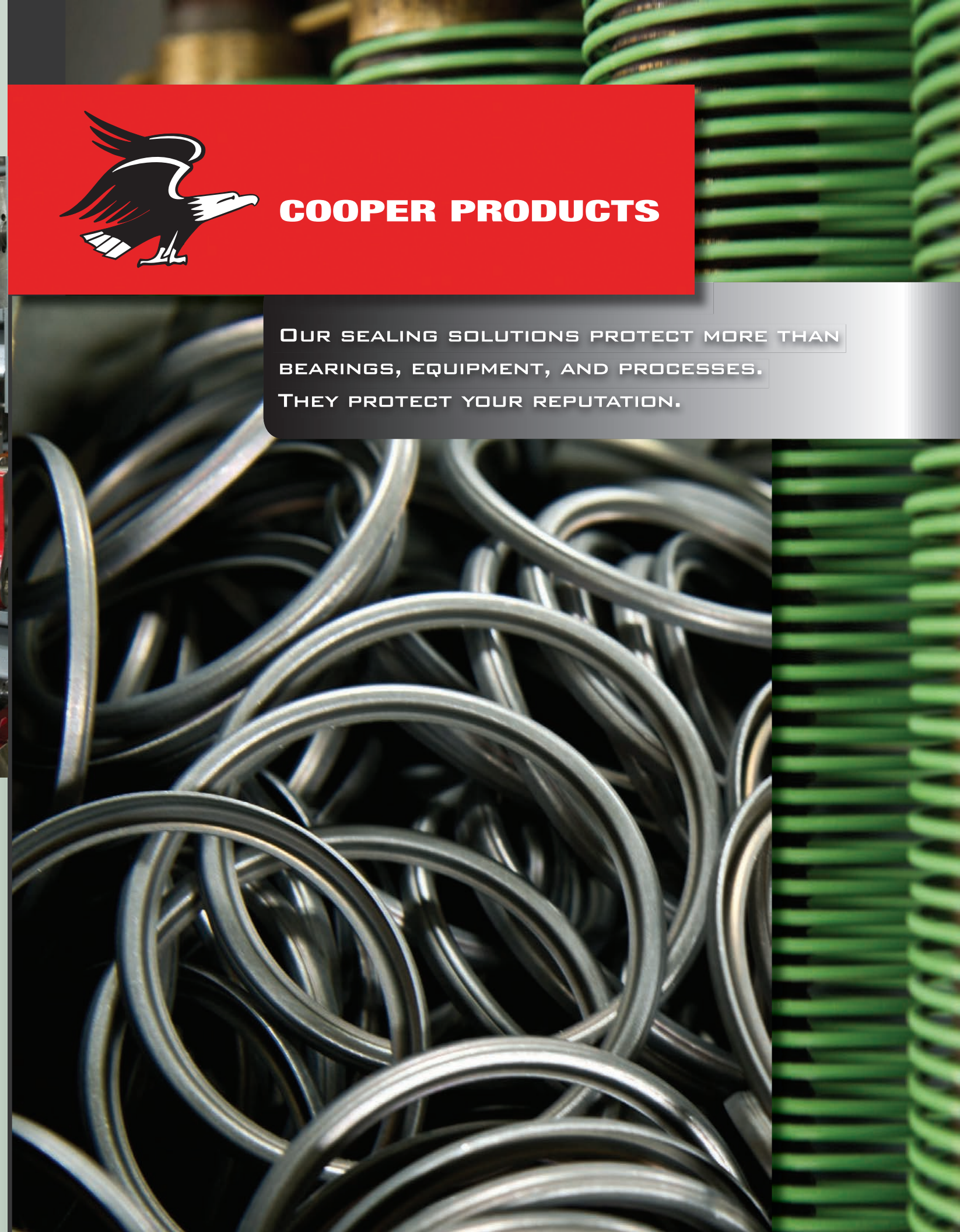

# CUSTOM RADIAL SHAFT SEALS & PRECISION MOLDED PRODUCTS

## Custom precision and so much more

At Cooper Products, we custom-make all of our radial shaft seals and precision molded products, maintaining tolerances of .001" or better on every job for optimal performance in automotive, aerospace, industrial, medical/dental, and other applications or processes. But what really sets us apart is our commitment to serving the most highly specialized needs of our customers.

## No challenge too big. No job too small. No project too demanding.

We are ready to take on your most unique or complex designs, even on lower-volume orders that our competitors won't touch. Our team of experts works harder than anyone else in the industry to engineer and manufacture the finest custom products you can get, in the quantities you want, at competitive prices. So go ahead, challenge us—and reap the benefits of custom precision at or near off-the-shelf prices.

## The Cooper trademark: exceptional customer service

Your specialized needs demand individual attention and personal service. And that's exactly what you get at Cooper Products. We understand that the success and profitability of your entire design, process, or product may rest on our ability to provide the perfect precision molded products on time at the right price. That's a responsibility we take very seriously. So when you call us, you talk to a person, not a machine. And should you have any questions or concerns, we will take as much time as you need to discuss them. At Cooper Products, serving your unique needs is more than a job—it's our privilege.

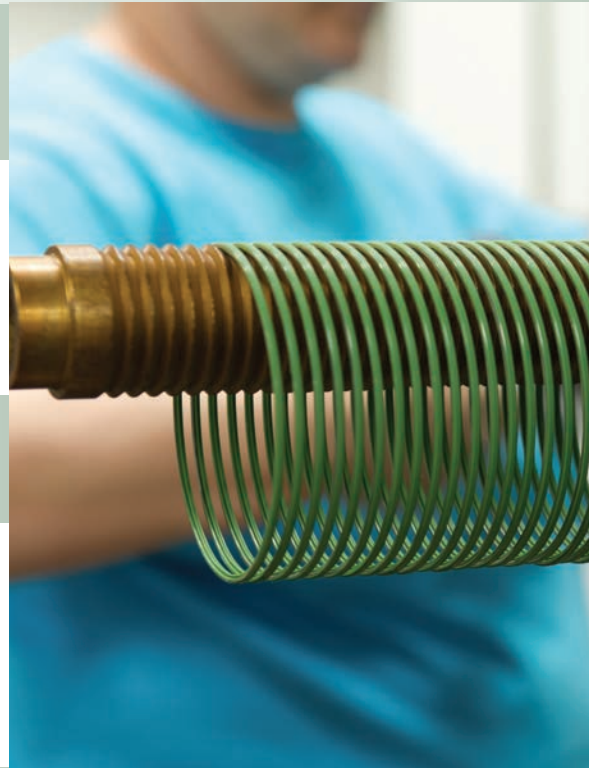

## Proudly made in the U.S.A.

We make all Cooper Products in our newly renovated 32,750-square-foot facility in Laconia, New Hampshire. We even make most of our own tooling. That means no waiting for parts. Shorter lead times. Less downtime. No extraneous shipping costs. Better quality control. And fine American craftsmanship built into every product we manufacture for you and your customers.

603.524.3367  
Fax: 603.524.4620  
seals@cooperproducts.com



# SEALS

Here is a small sampling of the typical products that Cooper Products manufactures for a variety of applications. (Dimensions in mm)

Please fill out the order form at [cooperproducts.com](http://cooperproducts.com) to get a quote on fully customized products for your design.

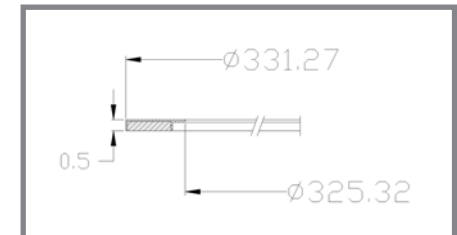
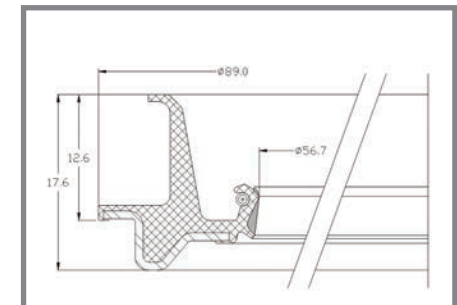
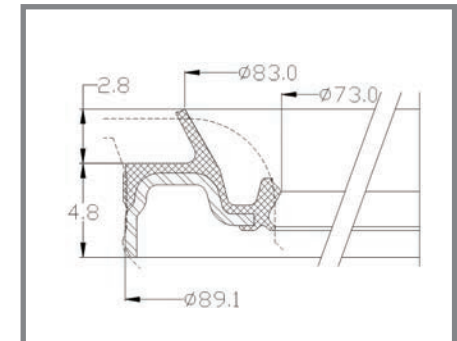
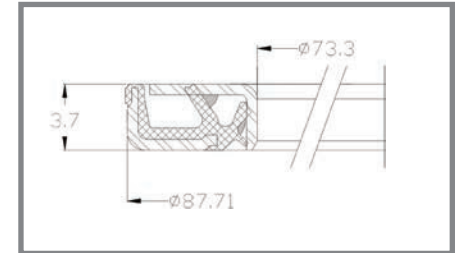
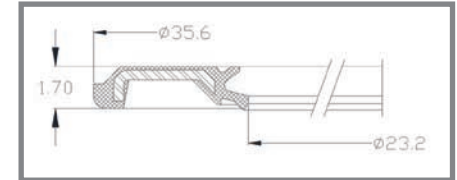
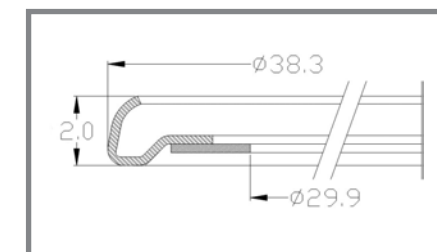
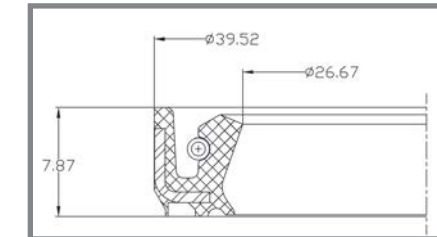
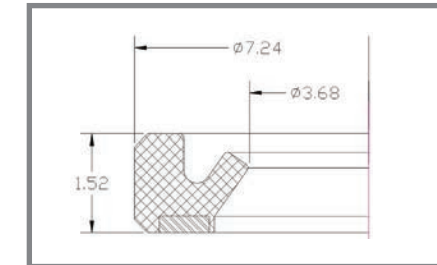
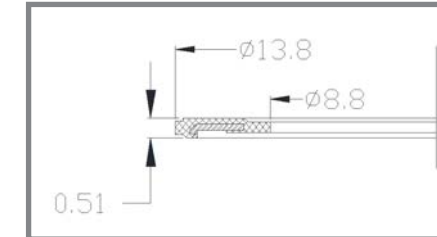
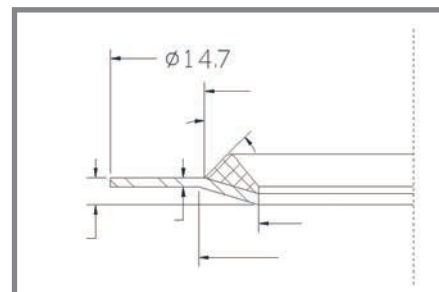
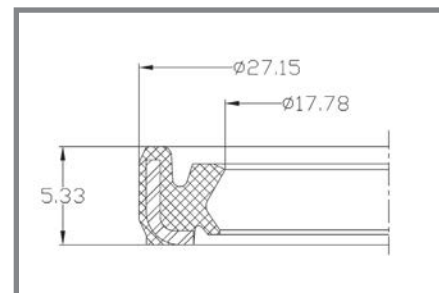
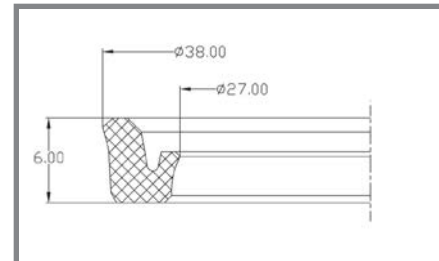
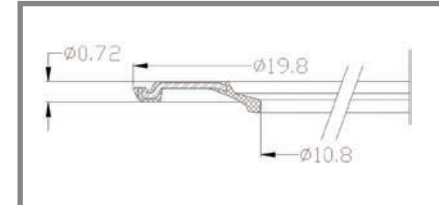
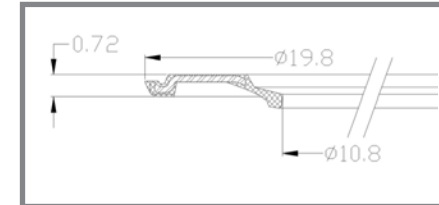

For more information or to submit your specifications, please visit us at [www.cooperproducts.com](http://www.cooperproducts.com).

ISO/TS 16949:2009  
certified